

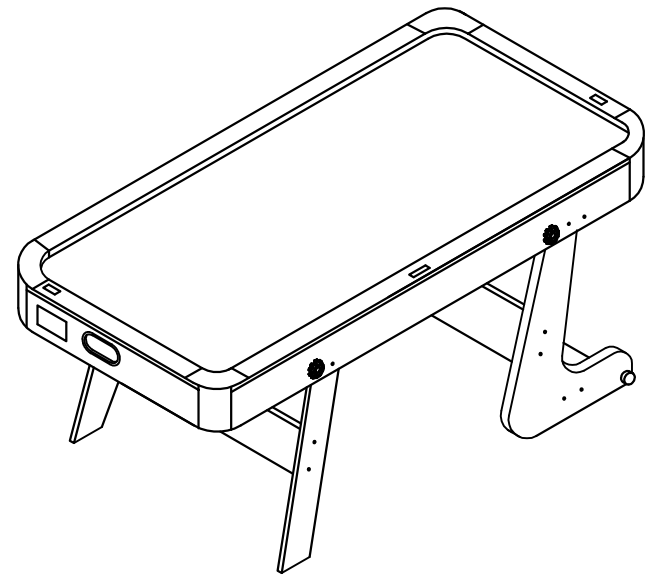

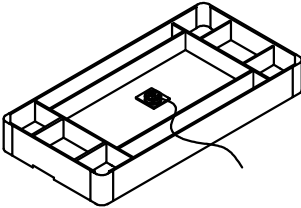







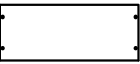

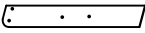
# HOCKEY TABLE

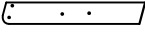

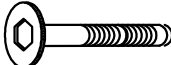
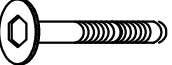

## ASSEMBLY INSTRUCTIONS

**PEGASI**



ASSEMBLY INSTRUCTIONS		
<p>P1</p>  <p>MAIN ASSEMBLY 1set</p>	<p>P2(A)</p>  <p>ANGLED LEG A 1pc</p>	<p>P3</p>  <p>LEG PANEL 3pcs</p>
	<p>P2(B)</p>  <p>ANGLED LEG B 1pc</p>	
	<p>P4A</p>  <p>LEG A 1pc</p>	<p>P5A</p>  <p>PLASTIC CASTER A 2 pcs</p>
	<p>P4B</p>  <p>LEG B 1pc</p>	
<p>P5B</p>  <p>PLASTIC CASTER B 2 pcs</p>		

<p>H1</p>  <p>1/16 BOLTS 4pcs</p>	<p>H2</p>  <p>1/4 BOLTS 12pcs</p>	<p>H3</p>  <p>1/16 WASHERS 8 pcs</p>
<p>H4</p>  <p>1/4 WASHERS 12pcs</p>	<p>H5</p>  <p>CYLINDRICAL NUT 12 PCS</p>	<p>T1</p>  <p>1/16 HANDLE BOLTS 4pcs</p>

<p>A1</p>  <p>HOCKEY PUCK 4pcs</p>	<p>A2</p>  <p>HOCKEY STRIKERS 4pcs</p>	<p>A3</p>  <p>TOOL 1 pcs</p>
<p>A4</p>  <p>BATTERY 4pcs</p>		

## ASSEMBLY INSTRUCTIONS

**WARNING: ASSEMBLE THIS TABLE WITH 2 PERSON**

1. Assemble each leg **P2(A )/P2(B)**, **P4(A )/P4(B)** by using bolts **H1**, **T1**, and washers **H3**.
2. Insert the nut **H5** into the hole of the leg panels **P3** as shown in **figure 1**. The hole of the nut align the hole of the panels.
3. Assemble leg panel **P3** by using bolt **H3** and washer **H4**.
4. Insert the leg caster (**P5A**) & (**P5B**) through the predrilled hole in the extremity of the leg.

